



Type VC61  
DN 15 – 400  
PN16-PN 40

## Globe Valve

Butt-Welded, Flanged

### Data Sheet

Edition: EN 9 / 2014

© VCEN VALVE CO.,LTD.  
Anfeng industrial zone, Oubei, Zhejiang, China  
T: +86 67969666, F: +86 67988805  
E: [vcen@vcenvalve.com](mailto:vcen@vcenvalve.com), W: [www.vcenvalve.com](http://www.vcenvalve.com)

We focus on quality  
[www.vcenvalve.com](http://www.vcenvalve.com)

### Application

- Designed for closing or throttling the liquid and gaseous medium
- **Fluids**  
Water, steam, air, crude petroleum and petroleum products, natural gas, gas condensate, technological solutions, oxygen, liquid and non-aggressive gases
- **Industry**  
Power engineering, chemical and petrochemical industry

### Technical description

- Stem is rotating, rising
- Valve opening is provided slowly, with gradual suspension of the stroke, to prevent hydraulic and thermal shocks in the valve
- Shutt-off valves can be operated in position open-close, throttling valve can be operated also in an intermediate position

### Testing

- The valves are pressure tested by water for strength and tightness in accordance with EN-12266  
Certification: PED/97/23/EC
- The minimum pressure for the strength testing is 1,5 x PN

### Installation

- The valve should only be installed in horizontal lines in an upright position
- Direction of flow see body mark

### Connection

- Butt-welded according to EN-12627, flanged according to EN1092-1 or to customer request
- Face to face dimensions according to EN-558-1

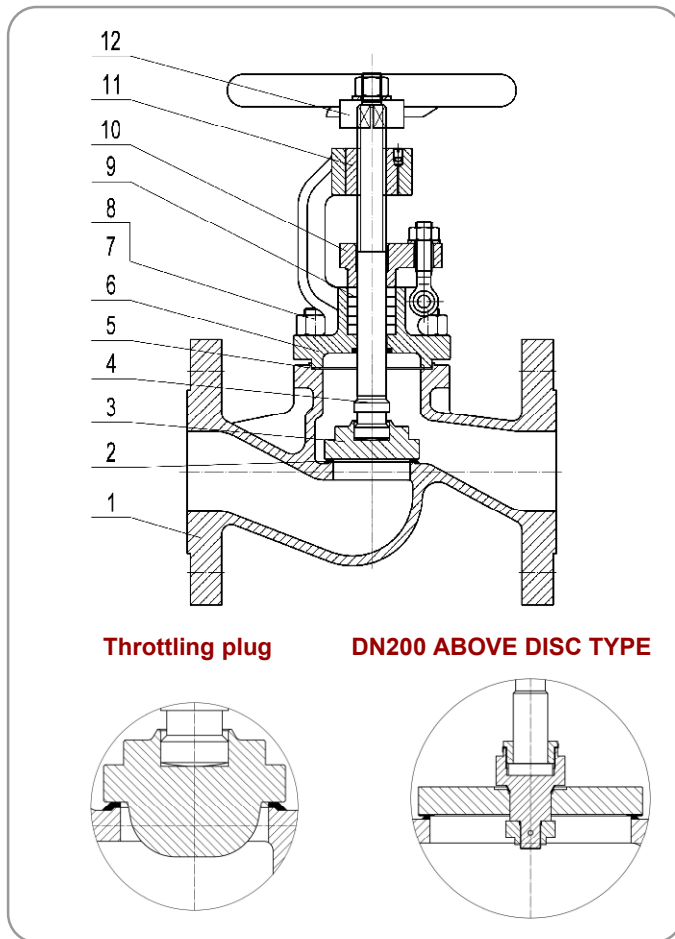

### Operation

- Hand wheel (with locking device, if required)
- Electric actuator
- Gear box
- Flange ISO 5210 (ready for actuator)

### Copyright

All rights reserved. No content provided herein may be copied, distributed or otherwise reproduced without previous written approval of the company  
YONGJIA VCEN VALVE CO.,LTD

© VCEN VALVE CO.,LTD CHINA 2014

### Contact

**VCEN VALVE CO.,LTD**  
Anfeng Industrial Zone,Oubei  
Town,Yongjia County Wenzhou  
City,Zhejiang Province,China

T: +86 6796 9666  
F: +86 6798 8805  
E: [vcen@vcenvalve.com](mailto:vcen@vcenvalve.com)  
W: [www.vcenvalve.com](http://www.vcenvalve.com)

**Materials of main parts**

Pos.	Name	Material
1	Body	1.0619 (A216 WCB), 1.7357 (A217 WC6), 1.4408 (A351 CF8M)
2	Seat	13Cr, STL6
3	Disc	A105,F316
4	Stem	X20Cr13, F316,
5	Gasket	Graphite + stainless steel
6	Bonnet	1.0619 (A216 WCB), 1.7357 (A217 WC6), 1.4408 (A351 CF8M)
7	Blot	A193 B7,A193 B16,A193 B8M
8	Nut	A194 2H,A194 4,A194 8M
9	Packing	Graphite
10	Gland	1.0619 (A216 WCB), 1.7357 (A217 WC6), 1.4408 (A351 CF8M)
11	Stem nut	GGG40.3;Cu alloy
12	Handwheel	C.S

**P-T data**

Materiál	PN	Pracovní tlak MPa / Pracovní teplota °C													
		100	150	200	250	300	350	400	425	450	500	525	550	575	595
1.0619 (A216 WCB)	16	1.36	1.27	1.14	1.04	0.94	0.88	0.84	-	-	-	-	-	-	-
	25	2.13	1.98	1.78	1.62	1.47	1.37	1.32	-	-	-	-	-	-	-
	40	3.41	3.17	2.84	2.60	2.35	2.19	2.11	-	-	-	-	-	-	-
1.4408 (A351 CF8M)	16	1,33	1,2	1,1	1,02	0,96	0,91	0,87	0,86	0,86	0,83	-	-	-	-
	25	2,07	1,87	1,72	1,6	1,5	1,42	1,36	1,35	1,34	1,3	-	-	-	-
	40	3,32	2,99	2,75	2,56	2,41	2,27	2,18	2,16	2,14	2,08	-	-	-	-
1.7357 (A217 WC6)	16	1,63	1,58	1,49	1,43	1,33	1,23	1,15	1,11	1,07	0,89	0,68	0,35	0,28	0,2
	25	2,54	2,48	2,33	2,23	2,08	1,93	1,8	1,73	1,67	1,39	1,06	0,55	0,43	0,32
	40	4,07	3,96	3,74	3,57	3,33	3,09	2,89	2,77	2,67	2,23	1,7	0,88	0,69	0,52

Note: the temperature not listed in the table is selected by linear interpolation method

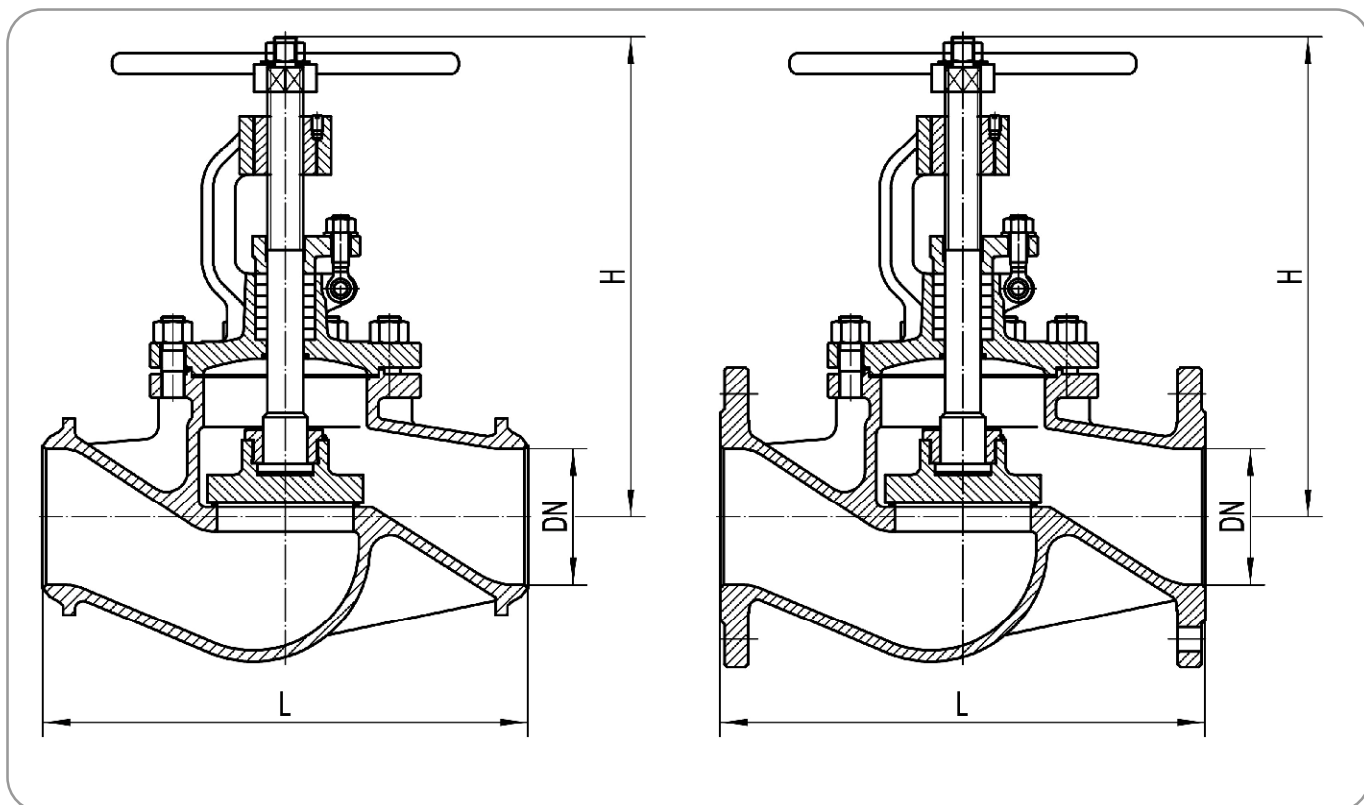

DN	15	20	25	32	40	50	65	80	100	125	150	200	250	300	350	400	
L(mm)	130	150	160	180	200	230	290	310	350	400	480	600	730	850	980	1100	
H(mm)	69	70	75	78	85	90	110	125	150	185	285	340	400	445	490	595	
STORKE(mm)	12	13	16	18	23	26	28	33	37	51	60	65	93	110	120	150	
Weight (kg) FL	PN16	3.8	4.5	5.5	7.1	9.5	11.5	19.2	25.2	34.2	53.1	75.5	151.2	305	410	580	820
	PN25	3.8	4.5	5.5	7.1	9.5	12	20.2	27.2	38.2	59.5	86.5	159.5	310	438	640	865
	PN40	3.8	4.5	5.5	7.1	9.5	12	20.2	27.2	38.2	59.5	86.5	163.4	323	453	680	850
Weight (kg) BW	PN16	2.2	2.7	3.5	3.8	5.4	6.8	13.4	19.2	28.2	45	67.5	105.5	228	316	415	595
	PN25	2.2	2.7	3.5	3.8	5.4	6.8	14.2	19.8	29.5	47.5	69.5	110.5	235	330	440	610
	PN40	2.2	2.7	3.5	3.8	5.4	6.8	14.2	19.8	29.5	47.5	69.5	118.5	245	355	460	630
Kv	4.6	8	13.2	21	33	51	83	133	205	315	454	780	1285	1805	2225	2906	